

## SEMI-INERT HIGH DENSITY INTERFACE (HDI) 3-WAY SOLENOID VALVE

The Lee Company's new perfluorinated semi-inert solenoid valve is specifically designed to handle moderately aggressive gases and liquids in a wide range of fluid handling applications. The valve is ideal for use in anesthesia delivery, inkjet printing, gas detection systems, reagent delivery and other OEM flow switching applications requiring moderate chemical resistance.

The valve's wetted materials include:

- Chrome Core 18<sup>®</sup> Alloy armature and plunger stop for superior corrosion resistance
- Epoxy
- 316 CRES spring
- PBT housing
- PFE/FFKM elastomer seal
- PPA plunger head

The Lee Company offers an array of standard manifolds for testing as well as customer-designed manifold configurations for production. Performance parameters can be optimized for a specific application.

Contact your Lee Sales Engineer for additional technical assistance and application information.

© Chrome Core 18 is a registered trademark of CRS Holdings, Inc., a subsidiary of Carpenter Technology Corporation.

PBT (Polybutylene Terephthalate)

PPA (Polyphthalamide)

- Light Weight: Less Than 4.5 grams
- Compact Size
- Superior Perfluoro Elastomer (PFE/FFKM) Inertness
- Low Internal Volume
- Response Time: 2 ms
- Flow Capacity: 3-Way; 1500 Lohms
- Operating Pressure Range: Vac – 45 psig (0-15 psid)
- Power Consumption: 850 mW
- Electrical Connection: 0.025" Sq. pin
- Saline Compatible

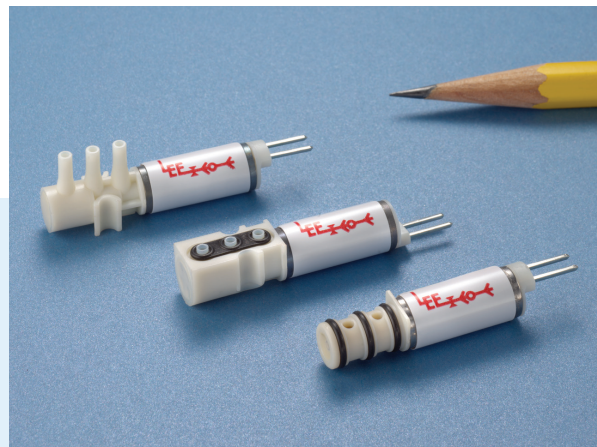

FLOW PERFORMANCE CHARACTERISTICS

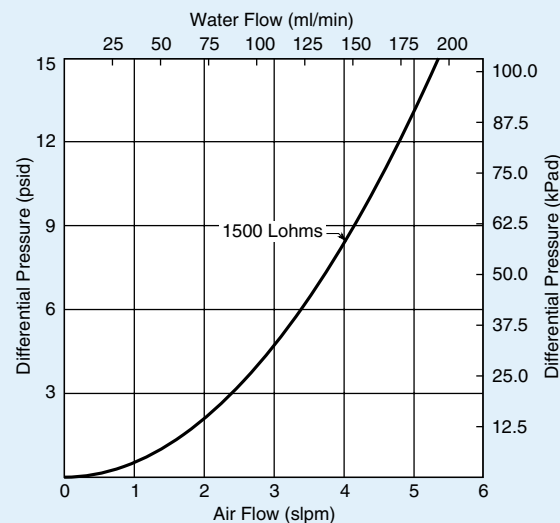

STYLE	LEE PART NUMBER	VOLTAGE (VDC)
Plug-In	LHDA0511515H	5
	LHDA1211515H	12
	LHDA2411515H	24
Face Mount	LHDA0521515H	5
	LHDA1221515H	12
	LHDA2421515H	24
Soft Tube Ported	LHDA0531515H	5
	LHDA1231515H	12
	LHDA2431515H	24

See dimensional drawings on reverse.

# SEMI INERT SOLENOID VALVE

## Plug-In Manifold

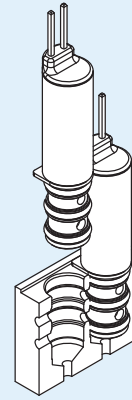
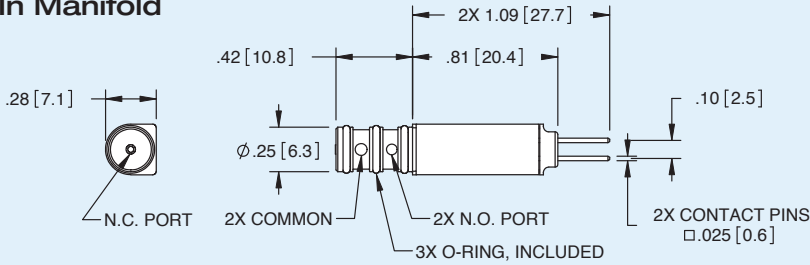

## Face Mount Manifold

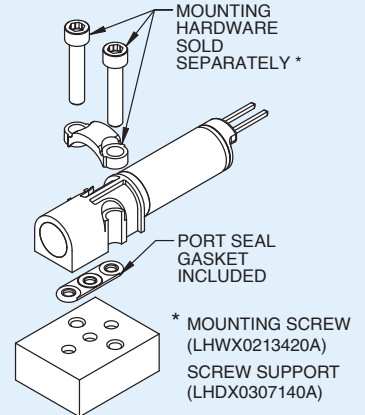
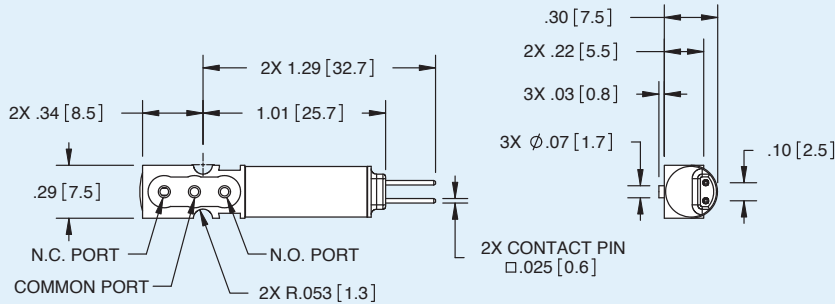

## Soft Tube Ported

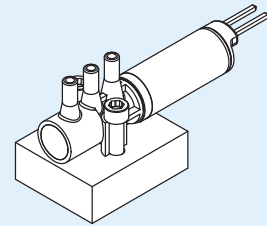
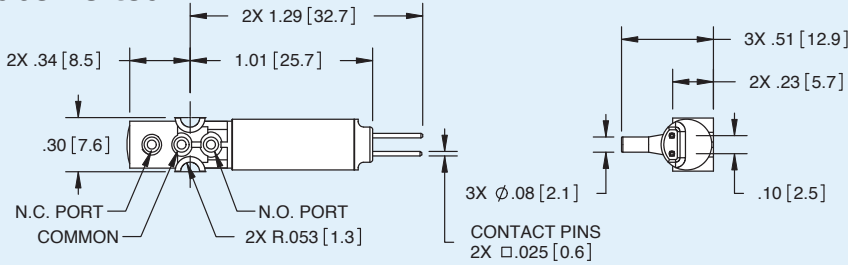

## Plug-In Boss Detail

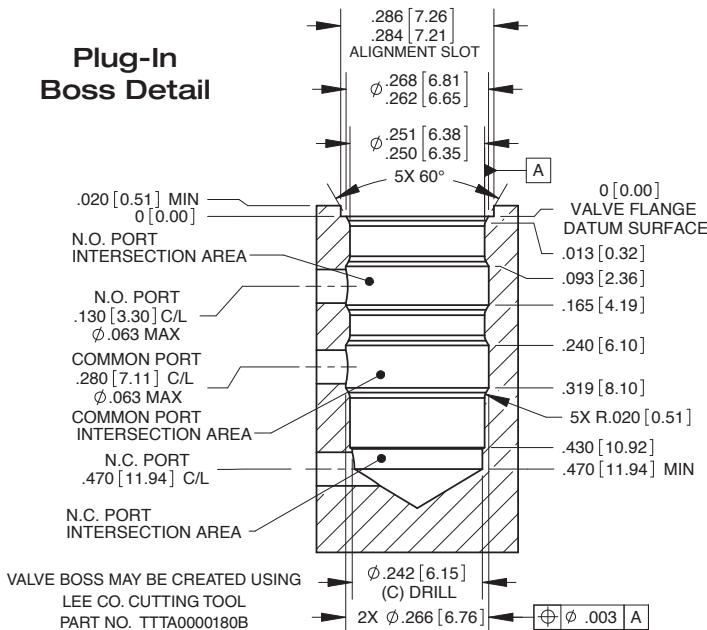

## Face Mount Boss Detail

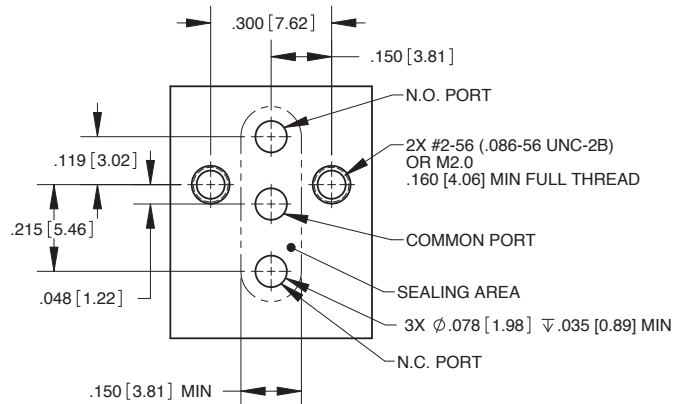

NOTE: Boss detail drawings not to scale.